



SIDEWINDER® ELECTRIC

MONITORS

Sidewinder® Electric

- Allows for more effective use of personnel while reducing the potential risk of injury — controls can be mounted inside vehicle
- Designed for wildland firefighting, de-icing, and dust abatement operations
- Weather-tight connectorized harness
- Epoxy encapsulated control module
- Available in 12V or 24V for DC operation
- Available with either a low-cost toggle box controller or full-sized joystick with integrated water valve trigger
- Double ball races with stainless steel bearings
- Available high speed water valve kit operates from joystick trigger

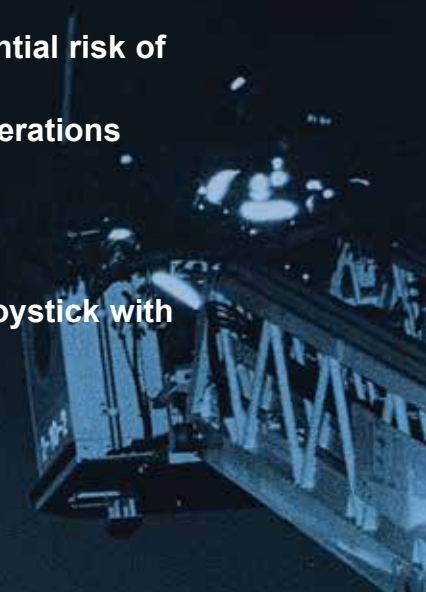

5-13

2" Fully-vented
waterway

Fully enclosed stainless
steel worm gears

Available
normal or
high-speed
travel

Electric motors
feature manual
override







200
PSI

500
GPM

CE

SPECIFICATIONS		
Max. GPM (LPM)	500 (1893)	
Inlet	Size	Type
	2"	NPT (F)
Outlet	1.5" NHT	
Controls	Electric	
Material/Finish	Elk-O-Lite® with red urethane enamel	
Friction Loss	26 psi at 500 gpm	
	13 psi at 350 gpm	
	3.9 psi at 200 gpm	
Travel	V -45° to +90° (135°)	
	H 180° or 334°	
Weight	16.5 Lbs.	
Max. Power Requirement	3.0 Amps at 12V DC (24V opt)	
Ratings and Certifications	CE	

KEY CONFIGURATIONS (ACCESSORIES)		
 TOGGLE CONTROL BOX (9)	 JOYSTICK CONTROL BOX (8)	 VALVE (4)
 QUICK CONNECT (10)	 CONTROL MODULE (12)	

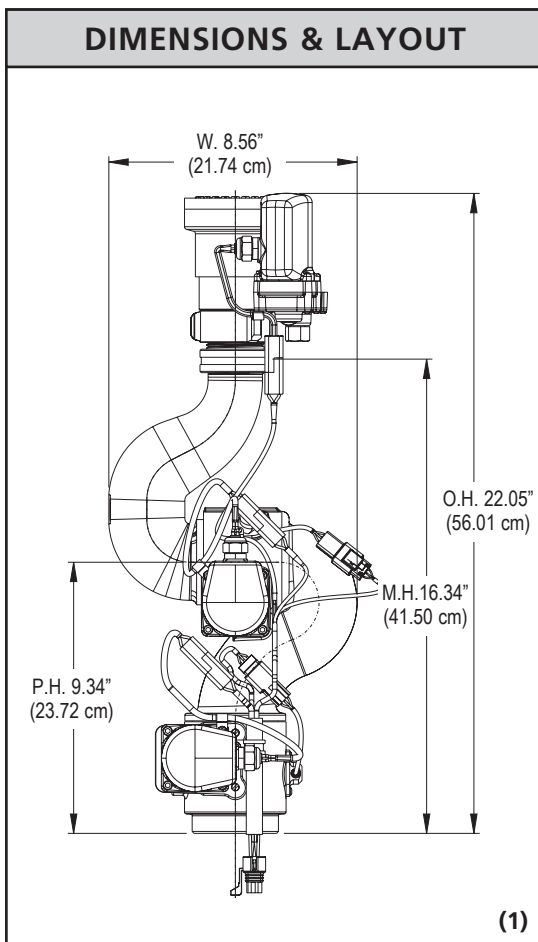

ADDITIONAL INFORMATION

Technical Data on monitor performance may be found on page T-11.

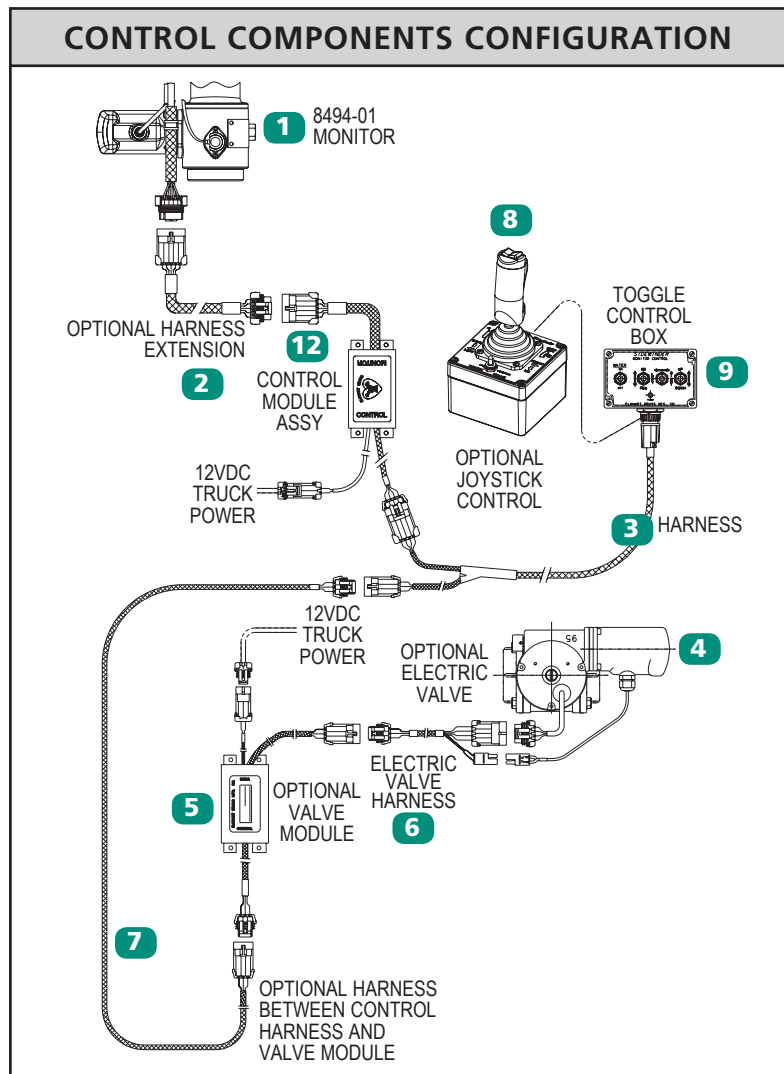



SIDEWINDER® ELECTRIC

Sidewinder® Electric Selector Guide

INLET SIZE / TYPE	OUTLET SIZE	HORIZONTAL TRAVEL		HORIZONTAL SPEED		VERTICAL SPEED		CONTROL MODULE VOLTAGE		BASES		CERTIFICATION	MODEL
		180°	334°	Fast	Slow	Fast	Slow	12V DC	24V DC	2.0" NPT	2" NPT Quick Connect (Elk-O-Lite®)		
2.0" NPT	1.5"	180°	334°	Fast	Slow	Fast	Slow	12V DC	24V DC	2.0" NPT	2" NPT Quick Connect (Elk-O-Lite®)	CE	
•	•	s	o	o	s	o	s	s	o	s	o	•	8494-01
											10		Illustration

KEY s = standard o = option

Components & Options Chart

COMPONENTS & OPTIONS			ILLUSTRATION	MODEL
Electric Nozzles	Selectable Gallonage	15/30/45/60/95/125/150/200 GPM	14	6000-200E
	Fixed Gallonage	15, 30, 45 GPM (specify)		5000-04
		60, 95, 125, 150 GPM (specify)	11	5000-14
		175, 200, 250, 350, 400, 475 GPM (specify)		5000-24
	Automatic	20 - 120 GPM	13	SM-10FE
Operator Controls	Toggle Box	With valve on/off control	9	
	Joystick	With toggle for water on/off plus integrated water valve trigger	8	
Monitor Control Module Assembly	Control Module	With 6" power harness. Specify operating voltage (12V or 24 V)	12	
	Monitor to Control Module Harness	1', 5' or 30' length (specify) Note: These harnesses may be combined for intermediate length - i.e., 5+5+1=11' length	2	
	Operator (Joystick or Toggle) box to Control Module Harness	12' or 50' length (specify)	3	
Valve Kit	2" Valve	High speed 2920E 2" valve	4	81181001
	Valve End Caps	Available inlet and outlet options are the same as those offered on the 2920E series of valves, please see page 7-19 (FNPT end caps are standard)		
	Valve Control Module	With 6" power harness. Specify operating voltage (12V or 24 V)	5	
	Valve Control Module to Valve Harness	5', 10', 20', 30', or 40' length (specify) Note: These harnesses may be combined for intermediate length - i.e., 5+10=15' length	6	
	Valve Control Module to Operator (Joystick or Toggle) Harness	Optional. 1', 3', 5', 10' or 25' length (specify)	7	
Dust Cover for Quick Connect Bases		Aluminum 3" x 3" push plug with stainless steel chain and safety tether. Used with either the Quick Connect (to keep contaminants out of the waterway and seal) or the harness connector (to keep contaminants out of the plug assembly).		

Recommended Products

5000-14 ELECTRIC NOZZLE	SM-10FE DE-ICING NOZZLE	281-A STREAM SHAPER	187CAF - SMOOTH BORE	6000-200E ELECTRIC NOZZLE
(11) 	(13) 			(14) 
Page 6-4	Page 6-4	Page 1-27	Page 1-29	Page 6-9