

MONITORS



PYTHON®

MONITORS

Python®

- Seamless brass 2.5" waterway for flows up to 1250 gpm
- Flexible installation options
 - Extensive base options
 - Two choices in manual controls — tiller or steering wheel
 - Hydrant mounting option
- All construction features designed to minimize maintenance needs
 - Corrosion resistant brass construction
 - Cast brass swivel joints
 - Bronze balls in all swivel joints
 - Stainless steel handles
 - Grease zerks for easy lubrication
- Positive twist locks for both vertical and horizontal movement



5-47



Tiller control allows fast action changes

Seamless tube



SPECIFICATIONS				
Max. GPM (LPM)	1250 (4732)			
Inlets	Sizes		Types	
	6"	150# ANSI Flange		
	4"	150# ANSI Flange	300# ANSI Flange	NPT (F)
	3"	150# ANSI Flange	300# ANSI Flange	NPT (F)
	2.5"	150# ANSI Flange	300# ANSI Flange	NPT (F)
Outlet Size	2.5" NHT			
Controls	Steering wheel			
	Tiller			
Material/Finish	Brass with red urethane enamel or chrome-plated			
Friction Loss	24 psi at 1250 gpm			
	18 psi at 1000 gpm			
	11 psi at 750 gpm			
Travel	V -45° to +90° (135°)			
	H 360° (continuous)			
Weight	45.00 Lbs. (See specification chart)			
Ratings and Certifications	FM Approved, CE			

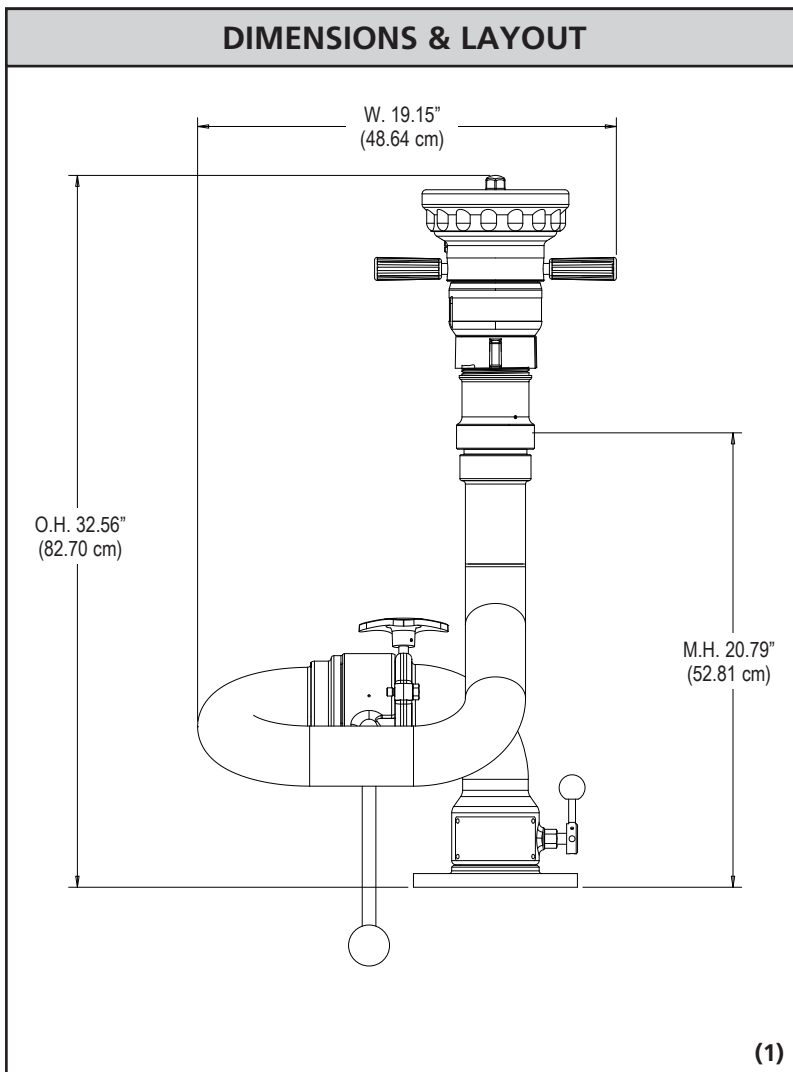

KEY CONFIGURATIONS (ACCESSORIES)



ADDITIONAL INFORMATION

- All flanges specified with the monitor are flat faced. Raised face flanges are available with some inlet sizes. Please inquire with our sales staff.
- Technical Data on monitor performance may be found on page T-11.
- The Python® is also available in a portable cart version. Please see page 5-61 for details.
- The Python® is also available in a hydrant mount version. Please see page 5-53 for details.



PYTHON®

MONITORS

Python® Selector Guide







INLETS											OUTLET SIZE	MAX. GPM (LPM)		CONTROLS				CERT.	DIMENSIONS				FINISHES		MODEL
SIZES / TYPES (INCHES)											SIZE / TYPE (IN.)	1250 (4732)	750 (2839)	Pressure Gauge	Steering Wheel	Tiller Bar	CE	FM Approved	Width (in.)	Depth (in.)	Height (in.)	Weight (Lbs.)	Red Urethane	Chrome-plated	
NPT			150# ANSI FLANGE				300# ANSI FLANGE				NHT														
2.5	3	4	2.5	3	4	6	2.5	3	4	2.5															
o	o	o	o	o	s	o	o	o	o	o	•	•	o												o
o	o	o	o	o	s	o	o	o	o	o	•	•	o	o	s	•	•	18.0	31.5	17.5	45.0	•	•	299-11P	
													3	2	1									Illustration	

KEY s = standard o = option
* Swivel

Components & Options Chart

COMPONENTS & OPTIONS		ILLUSTRATION	MODEL
Companion Flange Kits	3" 150# ANSI steel flange includes bolts and gaskets		81315001
	4" 150# ANSI steel flange includes bolts and gaskets		81317001
Drain Valve	Automatic ball drip drain valve.		702

Recommended Products

SM-1250B – X-STREAM®  <i>Page 6-7</i>	CJN-B – SELECT-O-STREAM®  <i>Page 6-12</i>	SM-1000HF – SELF-EDUCTING  <i>Page 6-16</i>	282B – STREAM SHAPER  <i>Page 1-27</i>
84 – BUTTERFLY WAFER VALVE  <i>Page 5-59</i>	296 – HYDRANT BASE  <i>Page 5-59</i>	181 – DELUGE TIP  <i>Page 1-29</i>	