

## OVERVIEW

Both Akron and Elkhart valve series are designed to swing out of the waterway by removing three of the bolts retaining each adapter (end cap), loosening the fourth then rotating the valve body out. Alternately all four bolts may be removed to slide the body completely out.

The primary difference in servicing the Akron and Elkhart valve will be that when servicing an Elkhart Unibody series the actuator shaft is always removed with the entire actuator subassembly off the top of the valve. The Akron actuator shaft, depending on the valve type, may need to be removed through the inside of the valve body. Due to the added complexity of removing the Akron valve actuator shaft, this o-ring should only be replaced if a leak has been detected in this area.

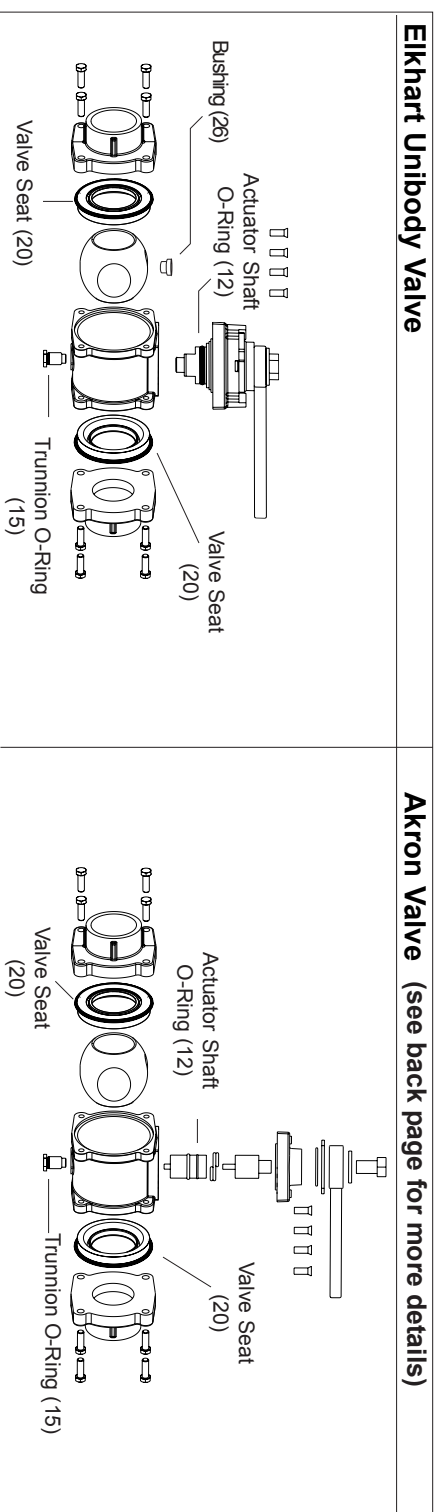

### I. DISASSEMBLY – BALL AND SEATS – AKRON AND ELKHART

**Note:** This kit includes extra O-rings for the different variations of valve. Identify the correct replacement O-rings when removing the old ones.

1. Turn the valve to the open position.
2. If the valve can be rotated out of line, remove three pairs of adapter bolts (18) and loosen the fourth pair. Swing the valve out of the line. If the valve cannot be rotated out of line, remove all eight adapter bolts and take the valve out completely.

**NOTE:** If it is necessary to remove the handle, mark the position of the handle in relation to the ball position, and the orientation of the stop plate (4) if so equipped.

3. Remove the two seats (20) from the valve body (21). It may be necessary to partially close the ball and grasp the inside lip of the seat.
4. Remove the threaded trunnion (16).
5. With the valve in the open position, remove the ball (19) and actuator bushing (26), if equipped (EB30/EB35 only).

### II. DISASSEMBLY – HANDLE TRUNNION AND/OR ACTUATOR SHAFT – AKRON ONLY (refer to back page for exploded view of different Akron actuator types)

**Note:** If servicing an Akron valve equipped with an electric actuator, do not disassemble this portion of the valve. The water tight seal will be broken and water may leak into the electronic controls chamber.

**Note:** If servicing an Akron valve equipped with a standard type handle, it is not normally necessary to replace the O-ring under the handle or on the actuator shaft. Do not disassemble this portion of the valve unless there is a leak.

1. Remove the handle bolt (1) and washer (2).
2. Note the position of the handle relative to the groove in the top of the actuator shaft for reassembly purposes. Remove the handle (3) and the stop plate (4), handle O-ring (6) and handle spacer (14) if so equipped.
3. The actuator shaft (12) of a 7600 (without actuator retaining plate), 8600 or 8800 series valve may now be removed by pushing it down into the valve. Pay careful attention to retain the thrust washer (22) as used on the 8600 and 8800 series valves.
4. For 7600 (with actuator retaining plate) and 7800 series valves, note the position of the actuator retaining plate (7) for reassembly purposes.
  - a. Remove the actuator retaining plate screws (5). Remove the actuator retaining plate (7).
  - b. Remove the handle trunnion (8).
  - c. Remove the lock sleeve (13) and spring (9) subassembly if applicable.

**Caution:** Do not remove the spring from inside the sleeve.

- d. Remove the actuator shaft (10) by pushing it out from the inside of the valve.

### III. REASSEMBLY – HANDLE TRUNNION AND/OR ACTUATOR SHAFT – AKRON ONLY

**Note:** Lubricate all O-rings with Parker O-Ring Lube or equivalent petroleum-based lubricant.

1. Replace the O-ring (12) on the actuator shaft (10) and reinstall the shaft in the valve body.
2. Replace the lock sleeve (13) and spring (9) sub-assembly and handle trunnion (8) if so equipped.

**Note:** The ears of the lock spring must be aligned with the corresponding recess of the actuator shaft. The pilot of the handle trunnion must fit into the hole in the center of the actuator shaft.

3. Reposition the actuator retaining plate (7), if so equipped, and install the screws (5).

**Note:** For valves with flat head screws, tighten all six screws until they just touch the plate before fully tightening any one screw. Tighten them in a criss-cross pattern. There should be a small gap between the plate and the valve body.

4. Install the handle O-ring (6), style 7600 handle spacer (14), and stop plate (4) as required.
5. Position the handle in the proper position, apply a small amount of Lockite 222 or equivalent to the handle bolt (1) and install the bolt with the handle washer (2).
6. Immediately test the operation of the handle. If it appears to be hard to turn, loosen the handle bolt approximately 1/4 turn.

### IV. DISASSEMBLY – ACTUATOR SUB-ASSEMBLY – ELKHART ONLY

**Note:** While easy, replacement of the actuator shaft o-ring is not normally necessary unless leakage is detected.

**Note:** If servicing an Elkhart valve equipped with an electric or gear actuator, access to the actuator sub-assembly retaining bolts is gained by removing the gearbox cover. The Unibody Valve Operating and Maintenance Manual includes more complete and detailed instructions of this process.

1. Note and mark the relative position of the actuator sub-assembly and any linkages
2. Remove the four socket head bolts (5) retaining the actuator sub-assembly.
3. Pull the entire actuator sub-assembly off the valve body.

### V. REASSEMBLY – ACTUATOR SUB-ASSEMBLY – ELKHART ONLY

**Note:** Lubricate o-rings with Parker O-Ring Lube or equivalent petroleum-based lubricant.

1. Replace the O-ring (12) on the actuator shaft (10).
2. Push the entire actuator sub-assembly down onto the valve body.
3. Replace the four actuator sub-assembly retaining bolts (5).

**Note:** The Elkhart actuator sub-assembly may also be assembled to the valve body after the ball is replaced and the body is back in position in the waterway.

### VI. REASSEMBLY – BALL AND SEATS – AKRON AND ELKHART

1. Install the new O-ring (15) on the threaded trunnion (16).
2. Use a 10" or larger flat file to clean up the flat surface of the adapters and mating surfaces of the valve body. Remove any paint, corrosion or raised lip around the bolt holes.

**Caution:** Always file diagonally and keep the file touching both sides of the valve body. The surfaces must remain flat.

3. Rotate the actuator so that the flats on the sides of the actuator shaft (10) are parallel to the waterway.
4. Install the ball (19) and actuator bushing (26), EB30/EB35 only, over the actuator shaft and hold it in position.
5. Install the threaded trunnion (16) so that it fits into the hole in the ball. If necessary, use fine emery paper to clean up the smooth portion that fits into the ball. The ball should fit loosely on the trunnion.
6. Tighten the trunnion.
7. Place the new seats (20) into the recesses on either side of the valve body (21).
8. Swing the valve body back into line or install the assembly. Loosely install the adapter bolts (18).
9. Turn the ball to the closed position.

**Caution:** The ball must be in the closed position before the adapter bolts are tightened.

10. Tighten the adapter bolts (18) evenly in an X pattern using 25-30 foot pounds of torque on 1.5" through 2.5" valves and 38-40 ft-lbs on 3" through 4" valves. **DO NOT OVERTIGHTEN.**
11. Operate the valve and test for leakage.

### MAINTENANCE INSTRUCTIONS

Do not lubricate the ball or seats. Lubricants can collect dirt and grit which may cause excessive wear. Occasionally, flow water through all valves to clear dirt and debris.

### OPERATING INSTRUCTIONS

Always open and close valves slowly. Do not exceed 500 psi.

## Akron Brass Detailed Valve Component View

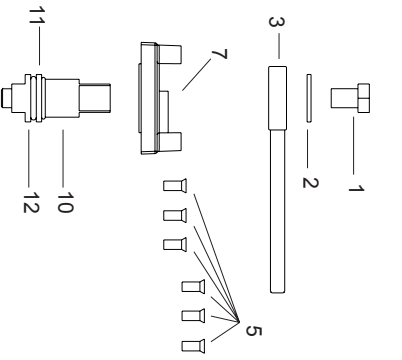
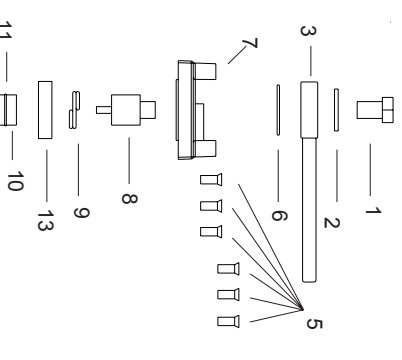
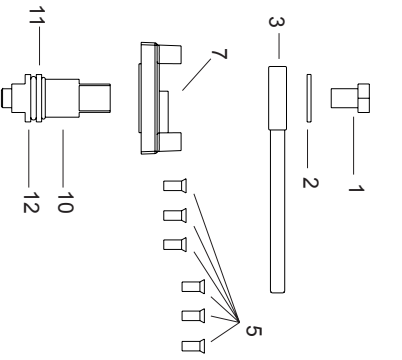
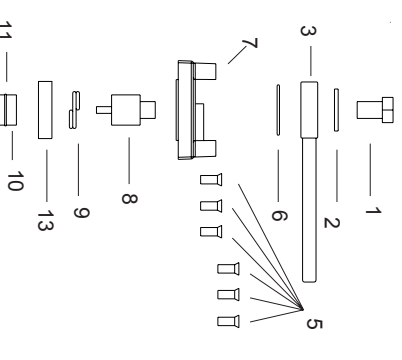
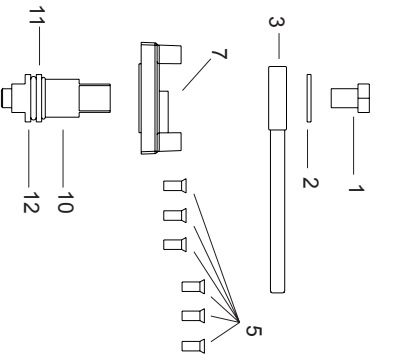
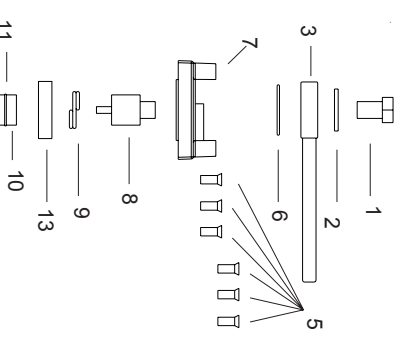
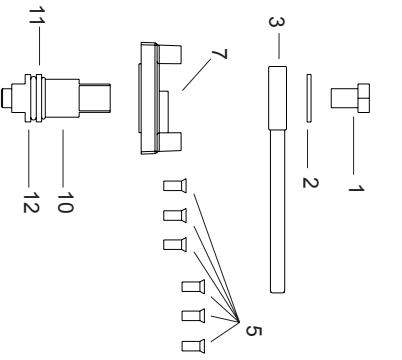
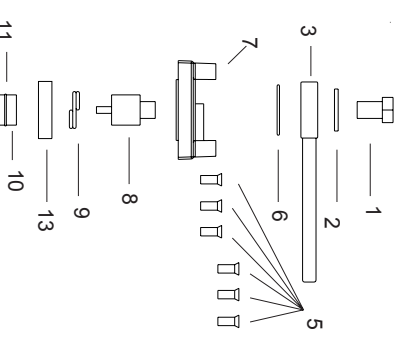
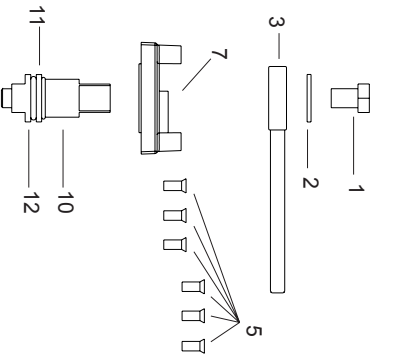
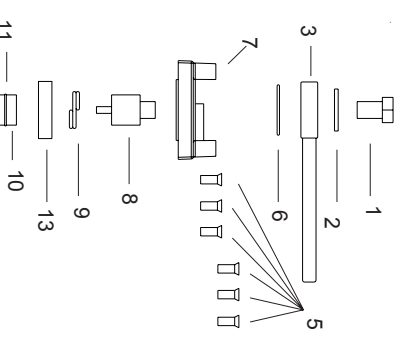
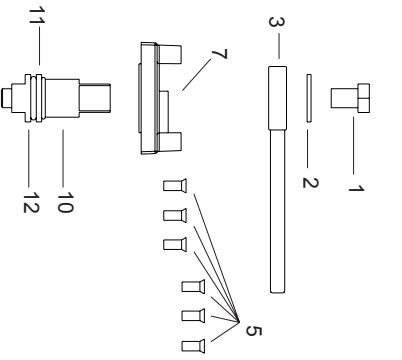
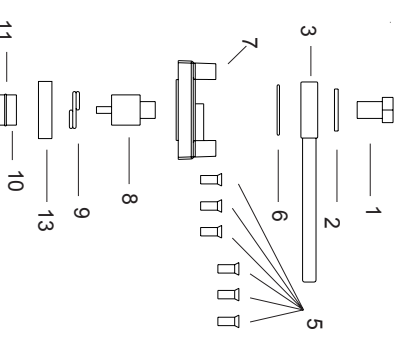
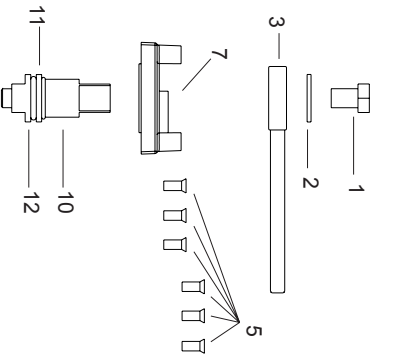
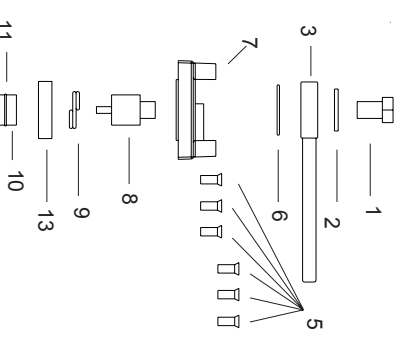
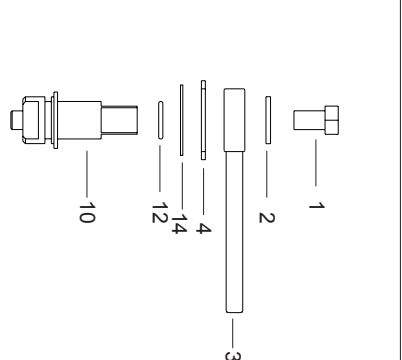
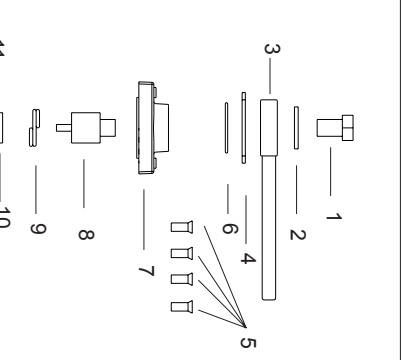
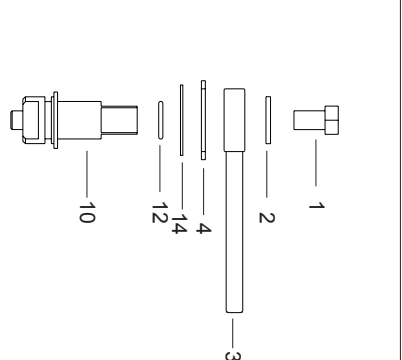
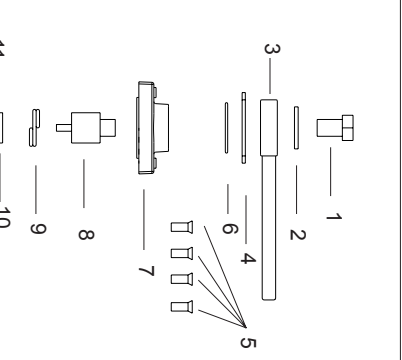
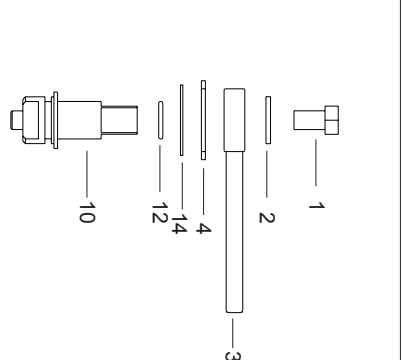
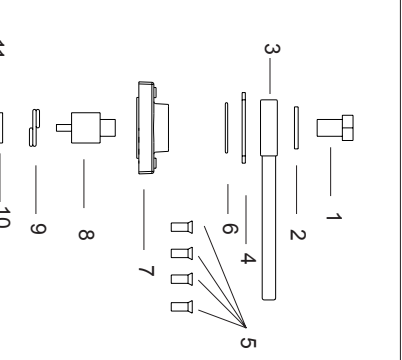
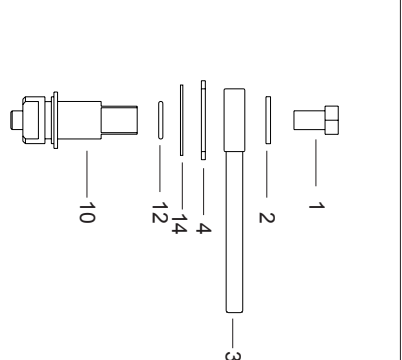
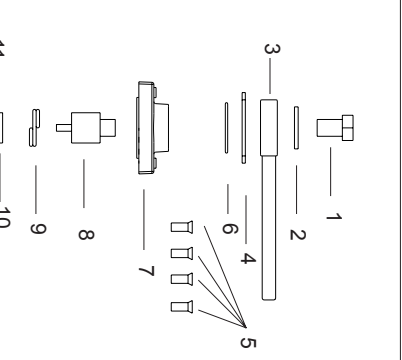
ITEM	DESCRIPTION	7600 Series Non locking with actuator retaining plate	7800 Series Locking with large stops built into actuator retaining plate
1	Handle Bolt		
2	Handle Washer		
3	Handle		
4	Stop Plate		
5	Actuator Retaining Plate Screws		
6	Handle O-Ring		
7	Actuator Retaining Plate		
8	Handle Trunnion		
9	Lock Spring		
10	Actuator		
11	Retaining Ring		
12	Actuator O-Ring		
13	Lock Sleeve		
14	Handle Spacer		
15	Trunnion O-Ring		
16	Trunnion		
17	Adapters		
18	Adapter Bolts		
19	Ball		
20	Seats		
21	Valve Body		
22	Thrust Washer		
23	Bushing		
24	Compression Spring		
25	Tabbed Spacer		
26	Actuator Bushing		

### General Valve Body

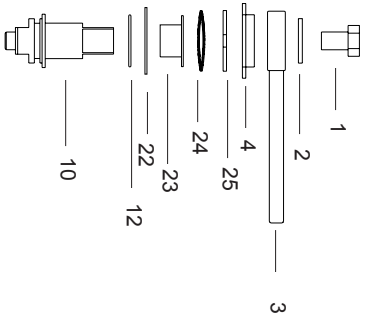
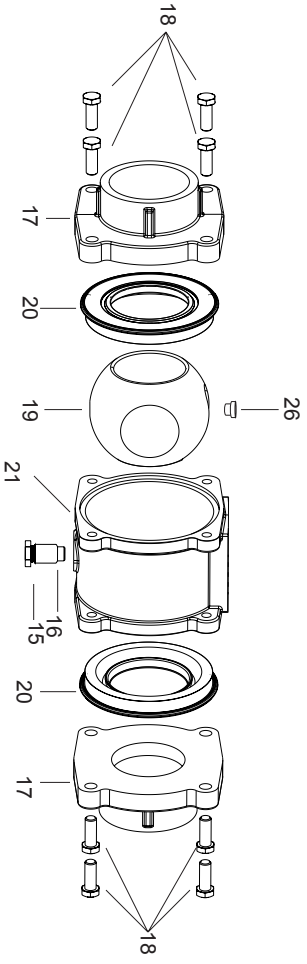

## Universal Seal Replacement Kit For Elkhart Brass and Akron Brass Apparatus Valves

Part Number	Fits Elkhart Brass Unibody Valve Series	Fits Akron Brass Series
65476000	EB15/EB20	8620/8820 7620/7820
65478000	EB25	8625/8825 7625/7825
65480000	EB30/EB35	8630/8830/8635/8835 7630/7830/7635/7835
65482000	EB40	8840

This service kit includes the parts required to replace both valve seats, the trunnion O-ring and the actuator shaft O-ring of either an Elkhart Brass Unibody series valve or an Akron Brass 7600, 7800, 8600 or 8800 series valve. A kit containing a stainless steel valve ball may be ordered separately to replace a damaged unit or to upgrade an Akron valve originally supplied with a plastic ball.



**ELKHART BRASS MFG. CO., INC.**  
1302 West Beardsley Avenue • Elkhart, IN 46514  
(800) 346-0250 • (574) 295-8330  
[www.unibodyvalve.com](http://www.unibodyvalve.com)