



Elkhart Brass

Fire Fighting Equipment

URFA-20S-2.5"

URFA-20-2.5"

URFA-25-2.5"

INSTALLATION AND OPERATING INSTRUCTIONS FOR FIELD ADJUSTABLE PRESSURE REDUCING/ CONTROLLING VALVES

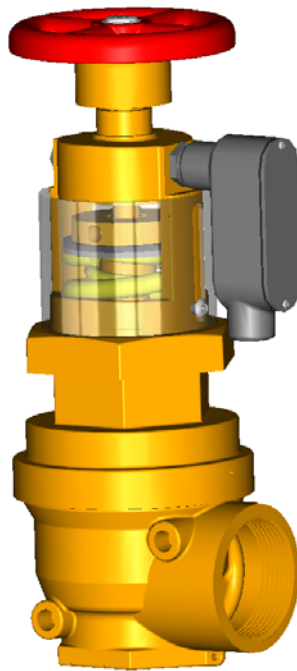

(URFA-20-2.5 MODEL SHOWN)

URFA VALVE MAJOR COMPONENTS

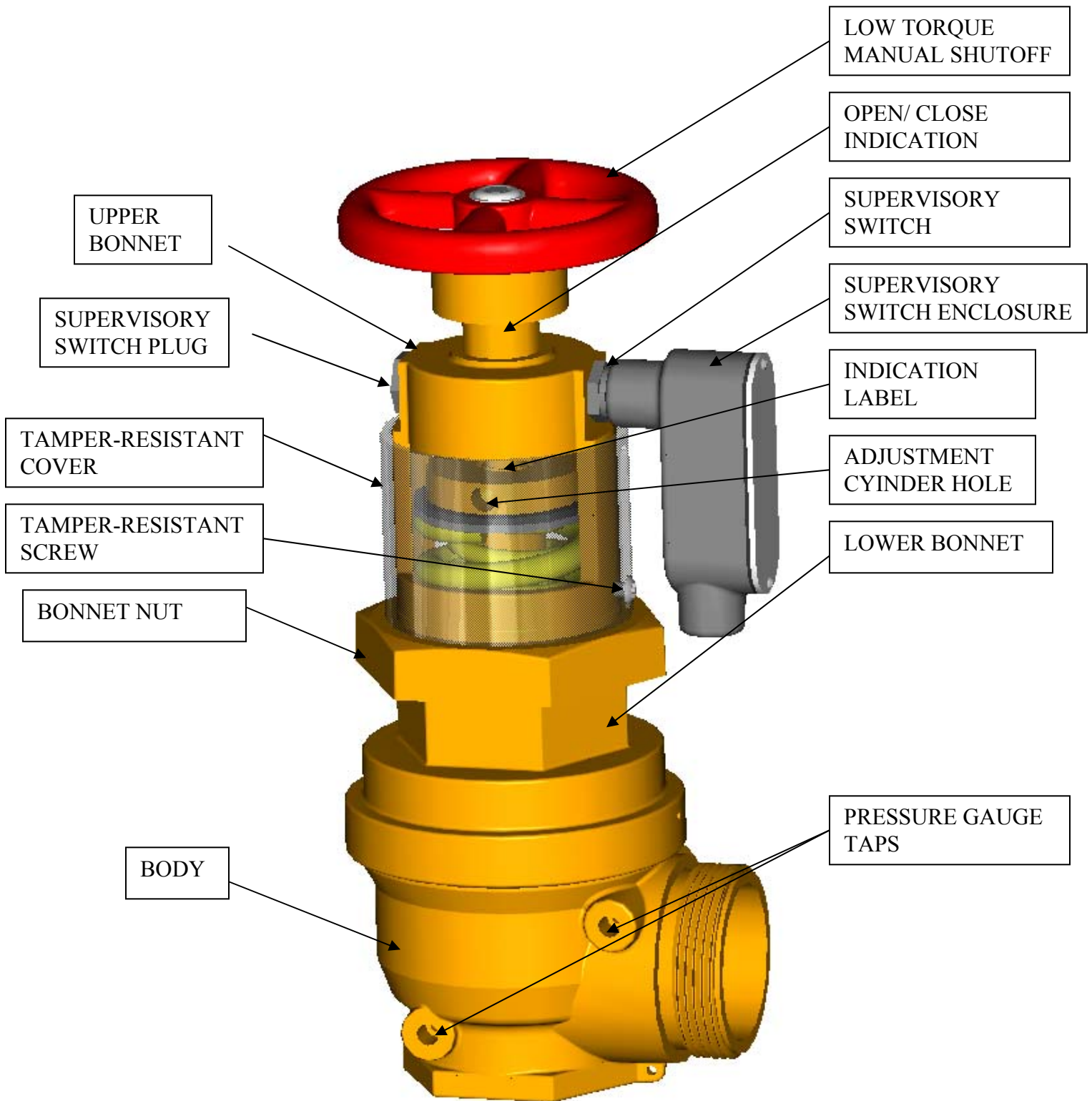

SPECIFICATIONS

- Pressure rated up to 400 psi.
- Flow rated up to 500 GPM
- Open-Close indication from 2 view directions
- Pressure reduction can be field adjusted
- Pressure reduction adjustment can be easily determined by indication label
- Pressure reduction adjustment has tamper resistant feature
- Low-torque manual close handwheel
- Built-in automatic check valve
- Regulates pressure under both flow and no-flow conditions
- Tapped for pressure gauge on both inlet and outlet side of valve
- Optional integral supervisory switch (For Indoor Use Only)

INLET – OUTLET CONNECTIONS

VALVE MODEL	INLET THREAD	OUTLET THREAD
URFA-20-2.5	2-1/2" FEMALE NPT	2-1/2" FEMALE NPT
URFA-20S-2.5	2-1/2" FEMALE NPT	2-1/2" FEMALE NPT
URFA-25-2.5	2-1/2" FEMALE NPT	2-1/2" MALE HOSE

APPLICATION

A. AUTOMATIC SPRINKLER SYSTEMS

The models URFA-20S-2.5 and URFA-20-2.5 valves are most commonly used in automatic sprinkler systems as floor control valves in high-rise buildings where supply riser pressures exceed 175 psi. The URFA valves are Listed by Underwriters Laboratories as “Special System Water Control Valves – Pressure Reducing and Pressure Control Type (VLMT)”, and also meet the listing requirements for indicating valves. Installation requirements for pressure reducing valves in automatic sprinkler systems are given in Section 4-6.1.2 of NFPA 13, Standard for the installation of Sprinkler Systems, 1999 Edition. When designing URFA pressure reducing valves into a sprinkler system a maximum flow rate of 400 GPM should be observed.

URFA Pressure Reducing Valves are also listed as checking devices, which eliminates the need for a separate check valve. When sprinklers on a given floor are fed from dual risers, the URFA valve acts as a check valve to prevent loss of sprinkler water supply in the event of one riser sustaining damage.

Requirements for Alarm Attachments are given in Section 5-15.1.6 of NFPA 13, Standard for the installation of Sprinkler Systems, 1999 Edition. An integral, listed supervisory alarm switch is available on URFA pressure reducing valves as option number “01” when ordering.

B. STANDPIPE SYSTEM

The models URFA-25-2.5 and URFA-20-2.5 valves are most commonly used in standpipe systems. The URFA-25-2.5 valves have a male hose thread outlet for connecting to fire suppression hose. When hose racks are used, the URFA-20-2.5 can be utilized along with a special hose nipple for support of the rack. The URFA valves are Listed by Underwriters Laboratories as Standpipe Equipment Pressure Reducing Devices (VUTX). Requirements for installation of pressure reducing valves in standpipe systems are given in Section 5-8 of NFPA-14, Standard for the Installation of Standpipe Hose Systems, 1993 Edition.

INSTALLATION REQUIREMENTS

A. AUTOMATIC SPRINKLER SYSTEM

1. To permit easy replacement or repair of valve, pipe unions or rubber gasket mechanical couplings should be installed immediately upstream or downstream of each URFA valve.
2. A relief valve of not less than ½ inch size is to be installed on the downstream side of each URFA valve
3. Pressure gauges are to be installed on the inlet and outlet side of each pressure-reducing valve
4. Valve adjustment setting should be selected to provide an outlet pressure not exceeding 165 psi at the maximum inlet pressure
5. Upon system completion, each Valve must be tested under both flow and no-flow conditions to verify that static residual outlet pressures and flow rates satisfy system design requirements. See Section 8-2.5 NFPA 13 for more information on mandatory flow and no-flow test requirements.

B. STANDPIPE SYSTEM

1. The URFA-25-2.5 can be used for both Class I and Class III service.
2. NFPA 14 requires that hose valve outlet pressures for Class I and Class III service be no greater than 175 psi. and no less than 100 psi. When permitted by the authority having jurisdiction, pressures less than 100 psi may be allowed, but in no cases shall the valve discharge pressure be less than 65 psi
3. Upon system completion, each valve must be tested under both flow and no-flow conditions to verify that static and residual outlet pressures and flow rates satisfy system design requirements. See Section 8-5.5 of NFPA 14 for more information on required flow and no-flow testing.

CONSTRUCTION & OPERATING PRINCIPLE

The URFA is a field adjustable pressure-reducing valve, which utilizes a hydraulic piston and cylinder assembly within the valve lower bonnet to allow the valve to self-throttle in response

to the pressure on the downstream side of the valve. Because the piston, main stem and valve seat float freely from the manual valve stem and handwheel assembly, the valve is able to self-close under static conditions and maintains a reduced pressure both under no-flow and flowing conditions. Valve discharge pressure is transmitted to the top side of the piston through pressure passages in the main stem. The presence of the piston results in a net area differential, which produces a hydraulic balancing force in the closed direction. The magnitude of this balancing force is in direct proportion to the hydraulic area of the piston.

The Field Adjustable feature of the valve is controlled by a spring within the valve upper bonnet. The spring adds an opening force to the main stem so that pressure reduction may be changed as the spring force is changed. This feature allows for the valve to satisfy all expected inlet/outlet pressure ratios. The Field Adjustable feature allows for one type of valve to be specified for all locations in a structure. Once installed the valves can be adjusted to the correct pressure reduction ratio based on their locations.

The URFA valves feature a patent pending manual close design that allows for extremely low torque of the handwheel while manually opening and closing the valve. The unique design allows for the independent operation of the valve stem from the manual close push-rod; this allows for the operator to bypass the large torque required to overcome the stiffness of the adjustment spring.

INSTALLATION OF VALVE

- The valve should first be plumbed into the system
- The upper bonnet may be rotated for optimized access to adjustment window
 - Loosen Bonnet Nut
 - Rotate Upper Bonnet to desired location of adjustment window
 - Apply service removable thread lock to the Bonnet Nut threads
 - Tighten the Bonnet Nut firmly
- See wire diagram for proper installation of supervisory switch
- The system should be slowly filled with water and purged of air
- The system should then be flushed to remove any debris

VALVE SETTING SELECTION

The URFA valves have settings of A, B, C, D, and E. Each valve setting corresponds to a pressure reduction graph located at the end of this manual. The valve setting is determined by where the top of the adjustment cylinder lines up on the Adjustment Identification Label located on the main stem (refer to Figure 1). To determine the correct setting for each URFA valve in the system design please use the following step.

1. Determine the standpipe or sprinkler riser residual pressure for each valve location. This is the inlet pressure at each valve under design flow conditions. In order to accurately determine these pressures, complete water supply data will be required, including results of municipal supply, flow test, and the pump performance curve. The URFA inlet pressure will be equal to the sum of the pump discharge pressure and the

municipal supply pressure at the design flow rate, less piping friction loss and elevation loss.

2. Turn to the appropriate valve performance chart. The valve model and flow range for each graph is indicated in the title at the top of the graph. Be sure to use the correct graph for the designed flow rate through the valve.
3. Locate the valve inlet residual pressure on the vertical axis of the chart and draw a line from the pressure horizontally across the chart.
4. Locate the desired valve outlet residual pressure on the chart horizontal axis and draw a vertical line from this pressure across the chart
5. From the intersection of the inlet and outlet pressure lines constructed in (3) and (4) above, move horizontally to the nearest valve performance curve (actually straight diagonal lines). This will be the appropriate valve setting for the chosen location.
6. Determine the valve static inlet pressure. This will be the sum of the municipal supply static pressure plus the pump churn pressure, less the elevation loss.
7. To determine the valve static outlet pressure, refer to the appropriate static chart. Locate the valve static inlet pressure on the vertical axis of the chart. Follow across to the appropriate valve curve and drop down to the horizontal axis to read valve outlet static pressure.
8. If static outlet pressure is found to exceed the maximum outlet pressure allowed by NFPA 13 or NPFA 14, it will be necessary to re-select a valve setting to the left of the originally chosen type.

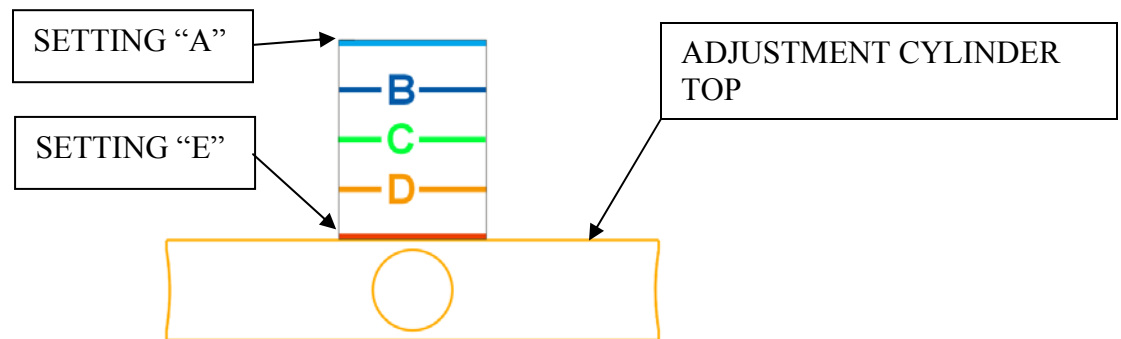

Figure - 1

SETTING PRESSURE REDUCTION

1. Remove the tamper-resistant screw from the clear cover by means of tamper-resistant Allen wrench provided with valve.
2. Insert adjustment tool provided with valve through the slot in the clear cover into the hole in the adjustment cylinder.
3. Rotate adjustment cylinder until the top of the adjustment cylinder is aligned with desired mark on the Indication Label (refer to Figure 1).
4. Once rotation limit is reached during adjustment remove the adjustment tool from the adjustment cylinder hole and re-insert the adjustment tool into the next available hole.

5. Once the proper adjustment is obtained verify the outlet pressure is correct with pressure gauges both upstream and downstream of the valve during both flow and no-flow pressure testing; make adjustments as needed. See Section 8-2.5 of NFPA 13 for more details on required flow and no-flow testing.
6. Once the valve is properly adjusted replace the tamper-resistant screw that was removed in step 2.
7. A tamper-resistant allen wrench and adjustment tool should be stored in a special location for Fire Department use.

NOTE: Rotating the adjustment cylinder clockwise will increase outlet pressure. Conversely, rotating the adjustment cylinder counter-clockwise will decrease outlet pressure.

SUPERVISORY SWITCH

Pressure reducing/ controlling valves that are to be used as part of a sprinkler system should include a supervisory switch to signal when a valve is not manually in the fully opened position (refer to NFPA 13 for more details on supervisory requirements). An optional supervisory switch assembly with UL approval for use with URFA valves is available on all models. The supervisory switch may be mounted to either side of the upper bonnet in the 3/4 inch tapped holes provided. A cap plug is secured in the upper bonnet tapped holes when the supervisory switch is not installed. A UL Listed conduit elbow is utilized as a water-resistant enclosure for the electronic switch. The conduit elbow provides an opening for fastening conduit to the enclosure, and a lid may be removed to gain access for wiring connections. The lid is attached with two pin-in-hex security screws. A key is provided for installation access into the conduit enclosure. Two switch options are available for the supervisory switch assembly. The first, part number 64040001, will provide a closed circuit when the valve hand wheel is in the full open position. The second option, part number 65755001, will provide an open circuit when the valve hand wheel is in the full open position. Please specify the required switch configuration when ordering. Figure 2 describes wiring details. The two switch options have different colored leads for easy identification. Part number 64040001, the closed circuit switch, has blue and green wire leads. Part number 65755001, the open circuit switch, has yellow and orange wire leads. The solid colored wires act as a primary wiring configuration and the striped wires act as a secondary or back up wiring configuration.

Figure - 2

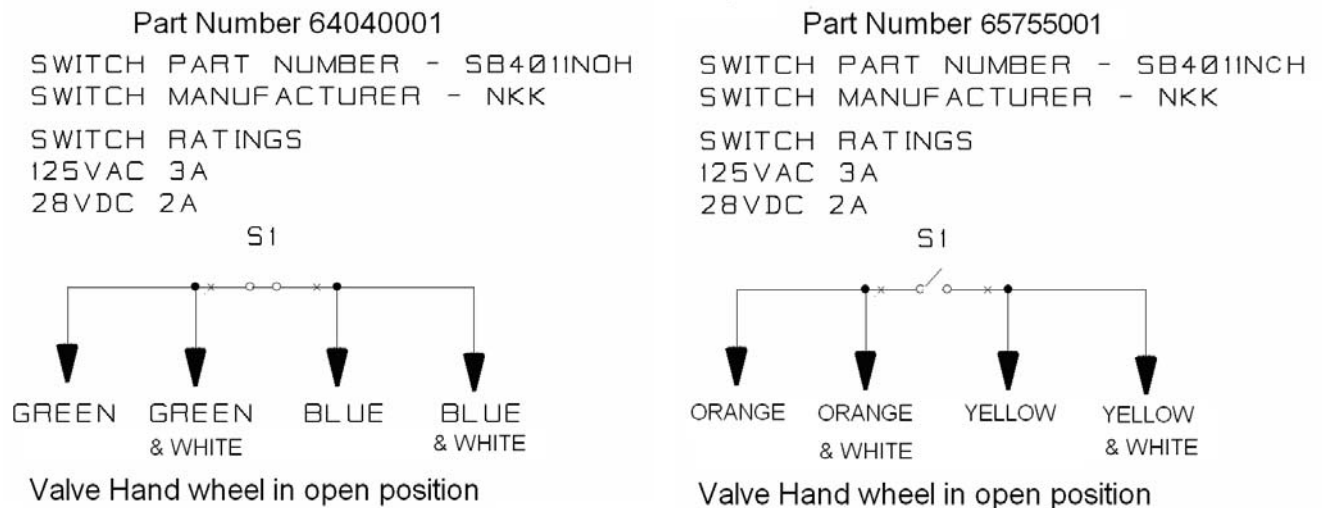

Note: Supervisory switch rated for Indoor Use Only.

The supervisory switch enclosure may be positioned with the conduit enclosure at various angles so to better meet space requirements (see Figure 3). To reposition the conduit enclosure angle, hold rotation on the hex adaptor fastened to the upper bonnet with the use of an open box wrench. While insuring the hex adaptor remains fully threaded against the upper bonnet, position the conduit enclosure to the desired angle. When completed the hex adaptor **MUST** be fully threaded against the upper bonnet to insure proper function. If the hex adaptor becomes unthreaded the supervisory switch will send an opened signal. Also ensure that the manual handwheel may be fully closed without interference from the supervisory switch assembly.

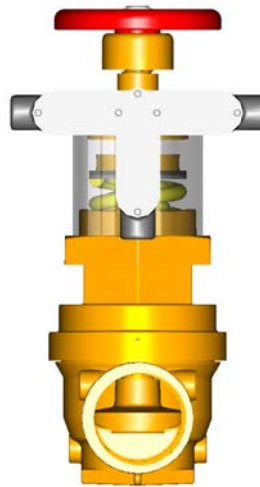

Figure - 3

VALVE CARE & MAINTENANCE

URFA valves require minimal maintenance. However, a routine inspection and test program is essential for any fire protection system to insure that it is in proper operating condition. NFPA 25, standard for the Inspection, Testing and Maintenance of Water-Based Fire Protection Systems should be consulted for a determination of required test frequency and methods.

Below is a summary of the required frequency of inspections and testing for pressure reducing valves:

Valve Application	Inspection	Flow Test
Sprinkler System Pressure Regulating Control Valve	Quarterly	Annually
Hose Connection and Hose Rack Assembly Pressure Regulating Valve	Quarterly	5-Years

Quarterly inspections should verify that the tamper-resistant cover is properly secured and compare actual valve adjustment settings to documented correct adjustment settings for each valve. If a valve is found to have incorrect valve setting it should be reset to the proper setting and undergo flow and no-flow testing to verify proper pressure reduction is obtained.

Flow test results should be compared to previous test results, and to system performance criteria. If the valve adjustment settings match the original and correct settings for each valve then no significant variance should occur from the original flow testing data.

NOTE: The outlet pressures shown on the following charts are subject to a tolerance of $\pm 10\%$.

URFA-20-2.5 & URFA-25-2.5
(50 GPM)

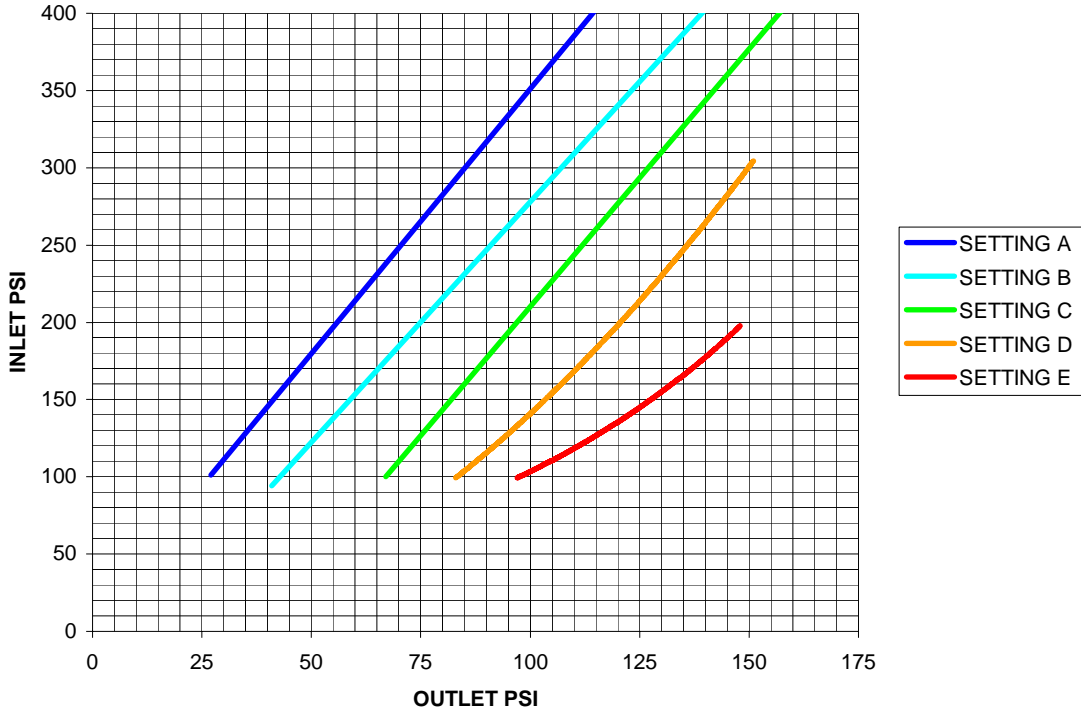

URFA-20-2.5 & URFA-25-2.5
(100 GPM)

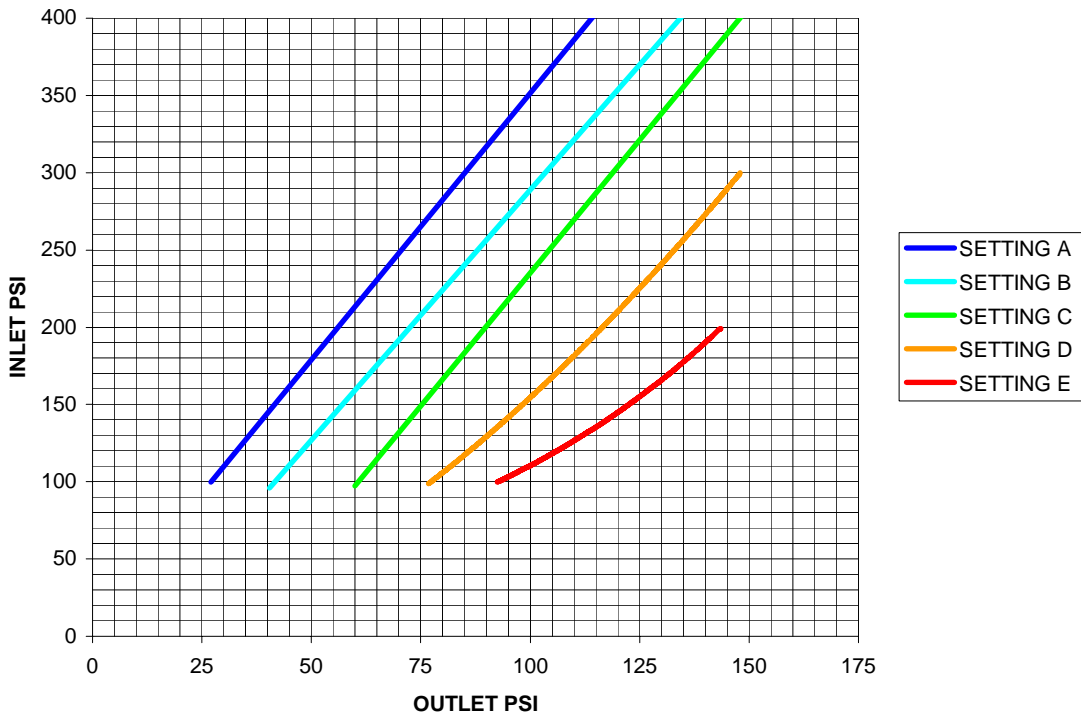

URFA-20-2.5 & URFA-25-2.5
(150 GPM)

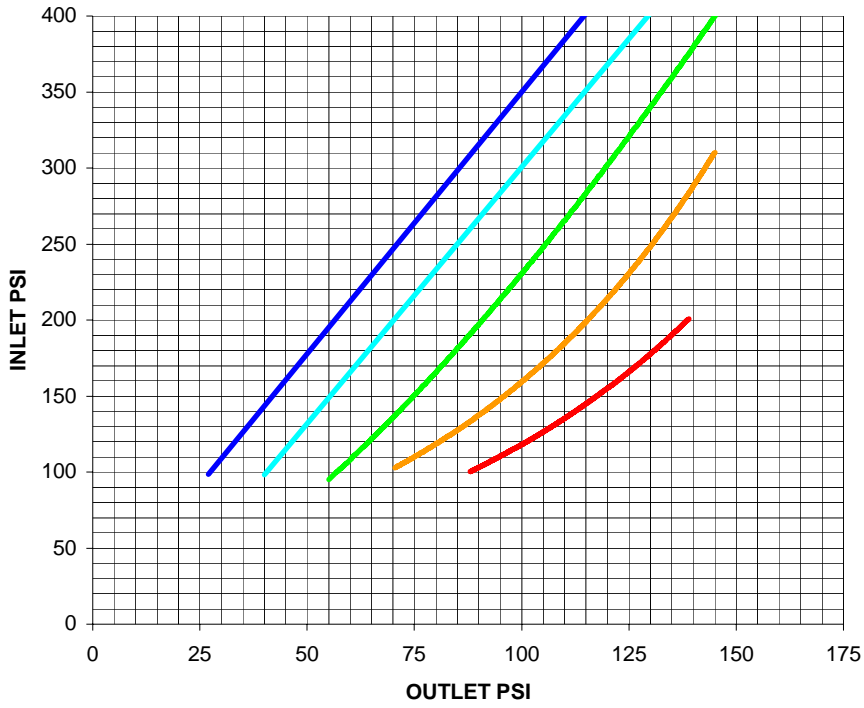

URFA-20-2.5 & URFA-25-2.5
(200 GPM)

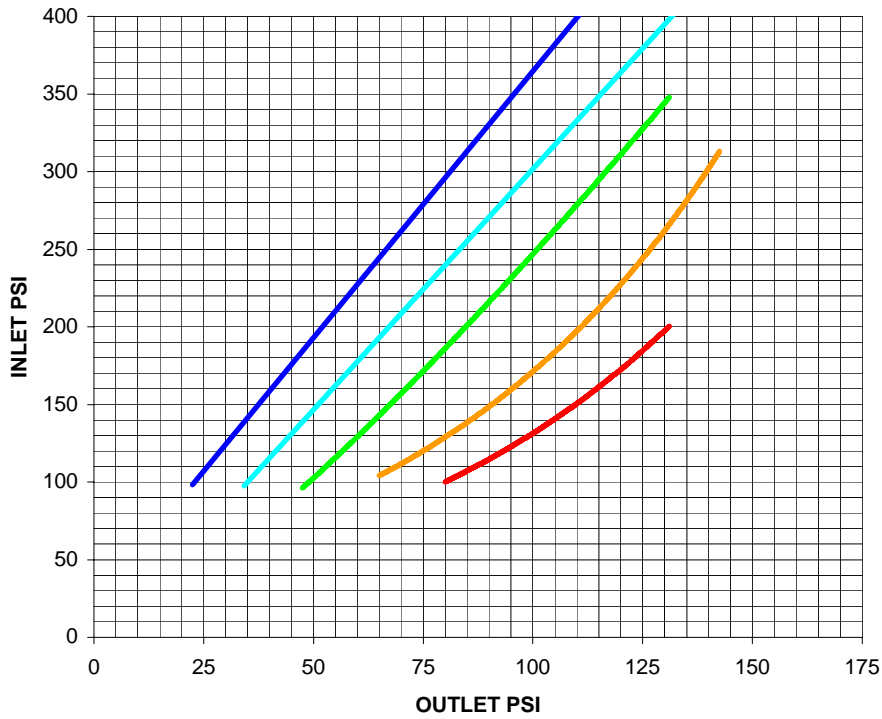

URFA-20-2.5 URFA-25-2.5
(250 GPM)

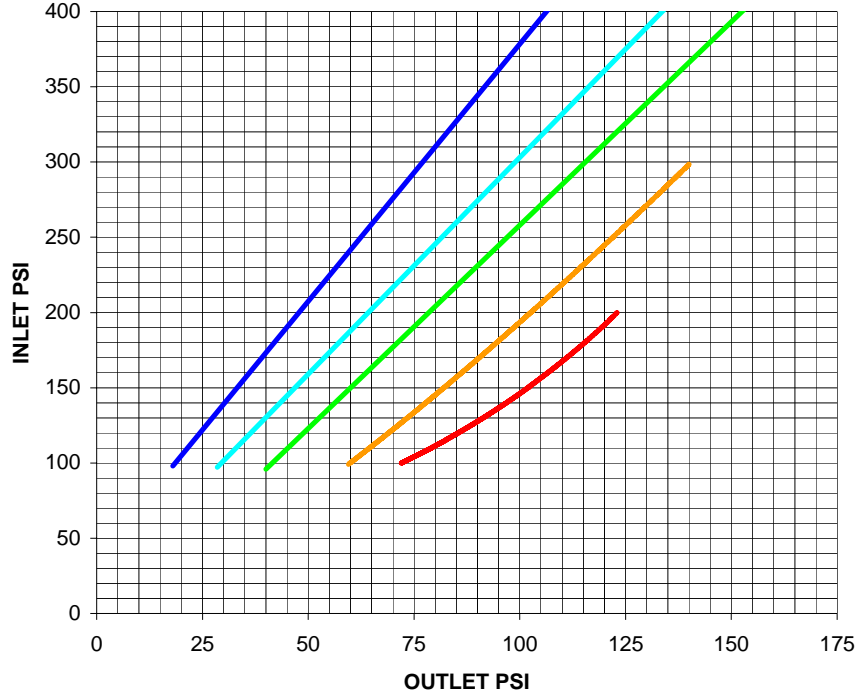

- SETTING A
- SETTING B
- SETTING C
- SETTING D
- SETTING E

URFA-20-2.5 URFA-25-2.5
(300 GPM)

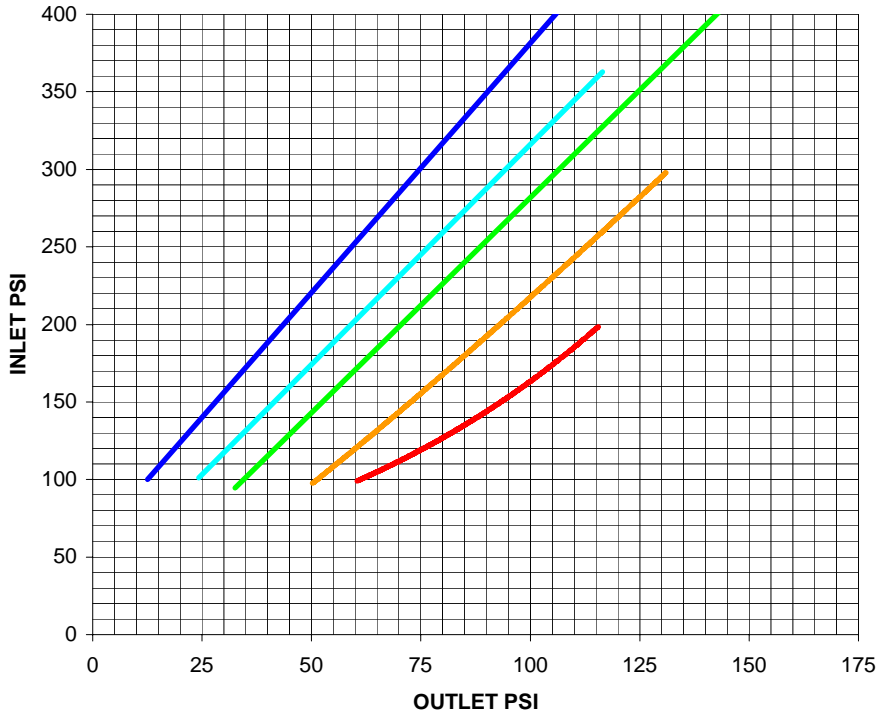

- SETTING A
- SETTING B
- SETTING C
- SETTING D
- SETTING E

URFA-20-2.5 & URFA-25-2.5
(350 GPM)

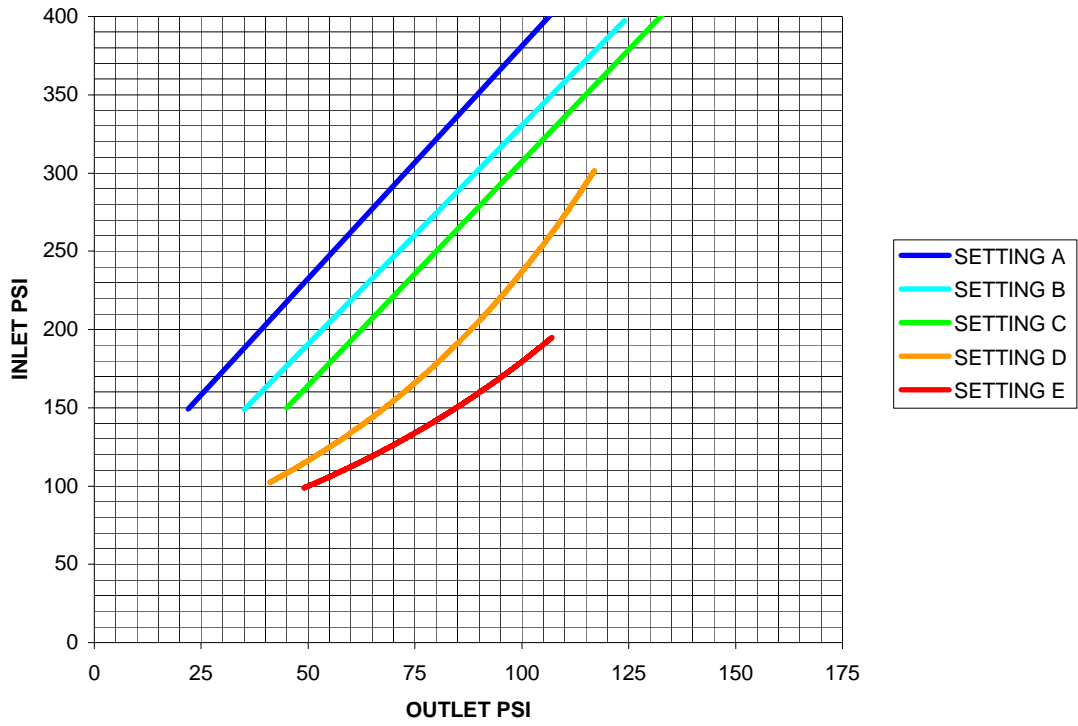

URFA-20-2.5 & URFA-25-2.5
(400 GPM)

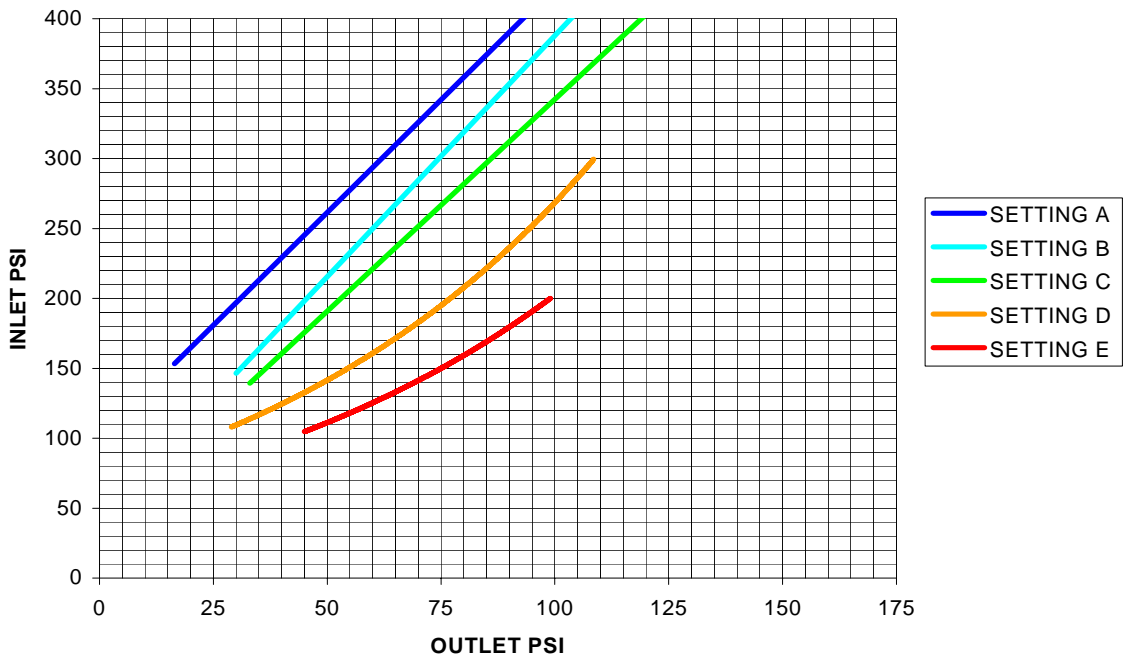

URFA-20-2.5 & URFA-25-2.5
(450 GPM)

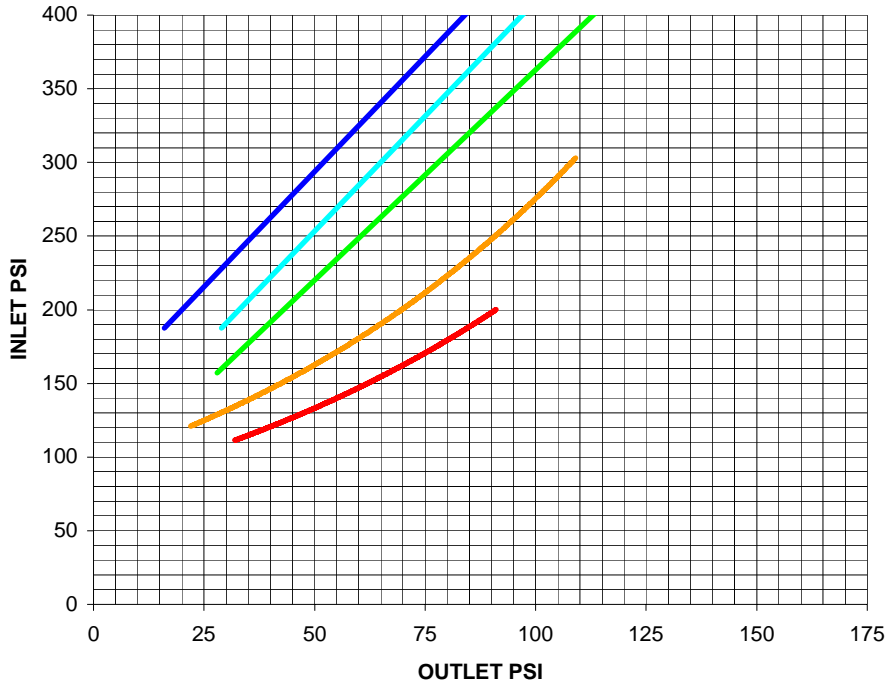

- SETTING A
- SETTING B
- SETTING C
- SETTING D
- SETTING E

URFA-20-2.5 & URFA-25-2.5
(500 GPM)

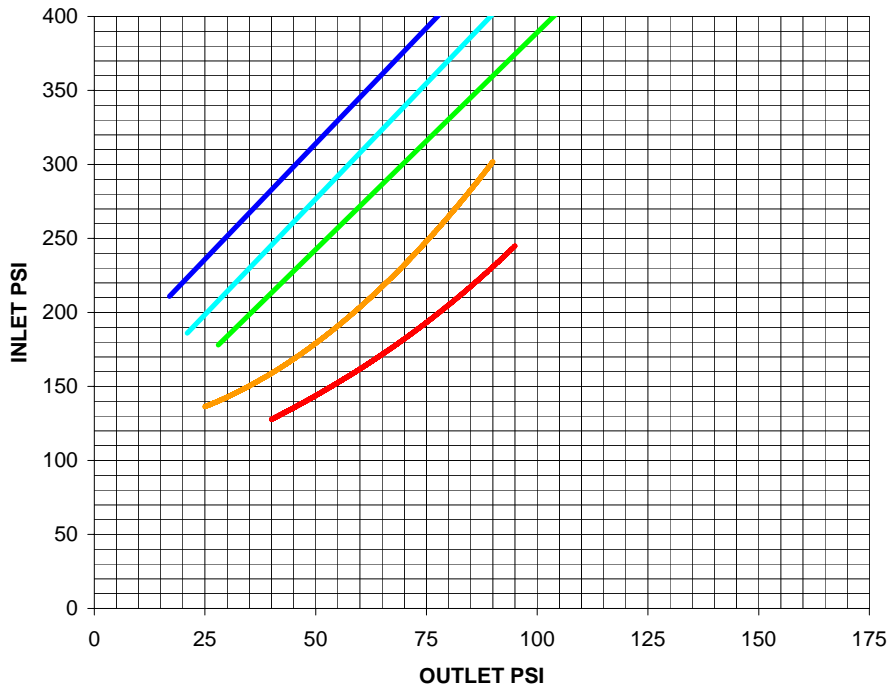

- SETTING A
- SETTING B
- SETTING C
- SETTING D
- SETTING E

URFA-20S-2.5
(50 GPM)

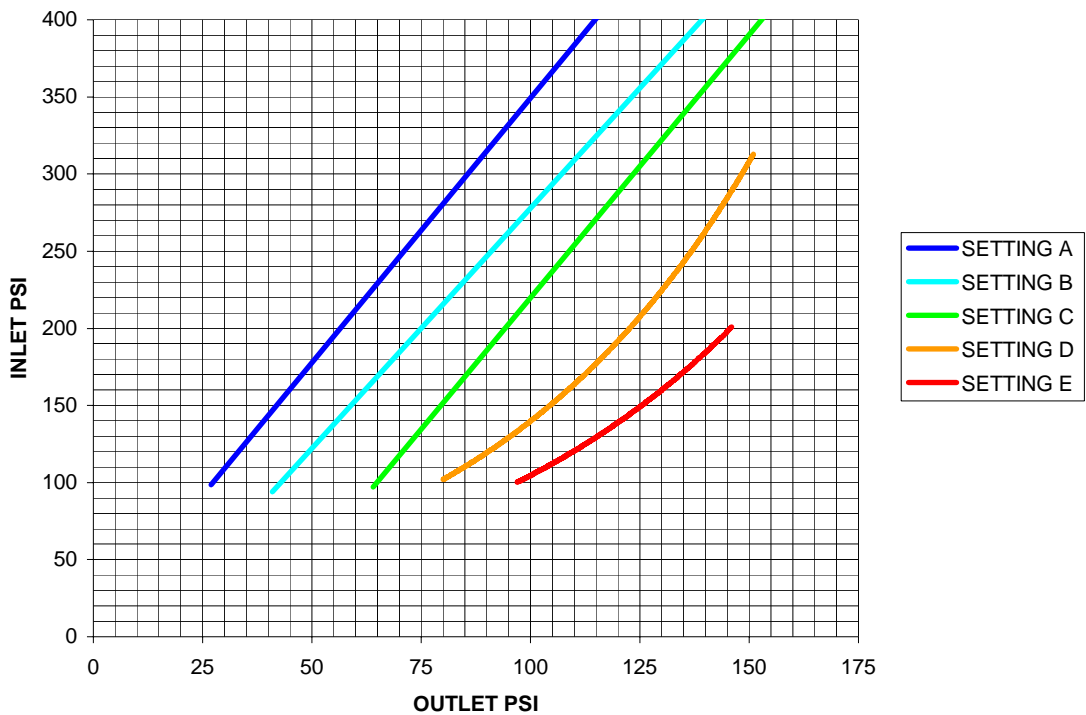

URFA-20S-2.5
(100 GPM)

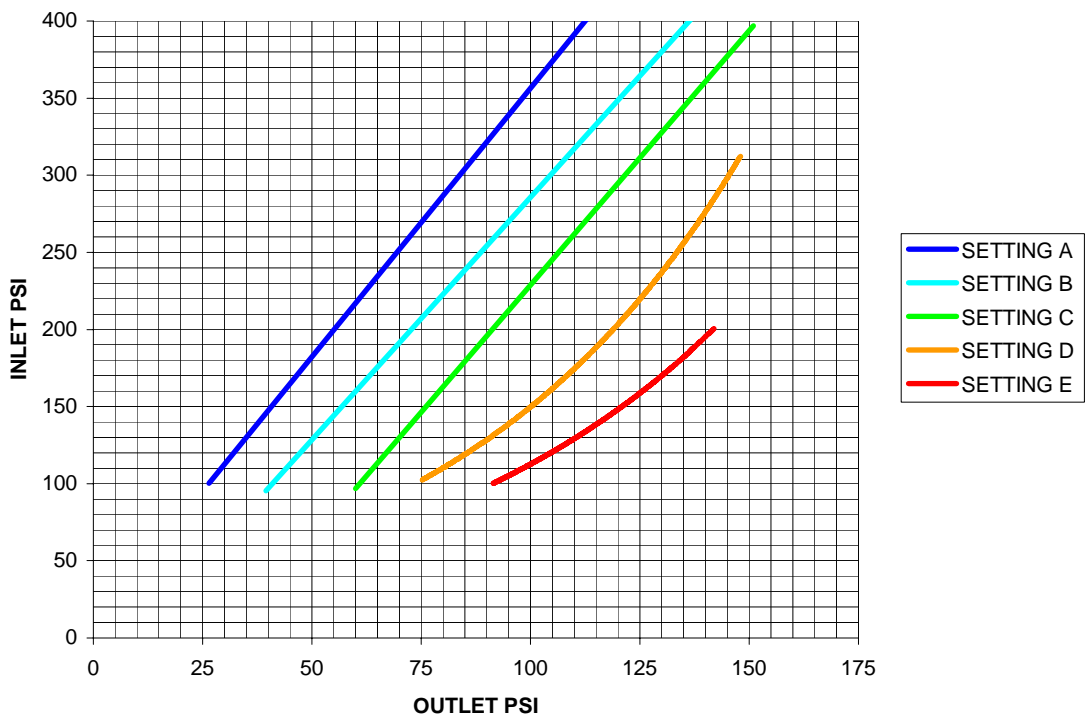

URFA-20S-2.5
(150 GPM)

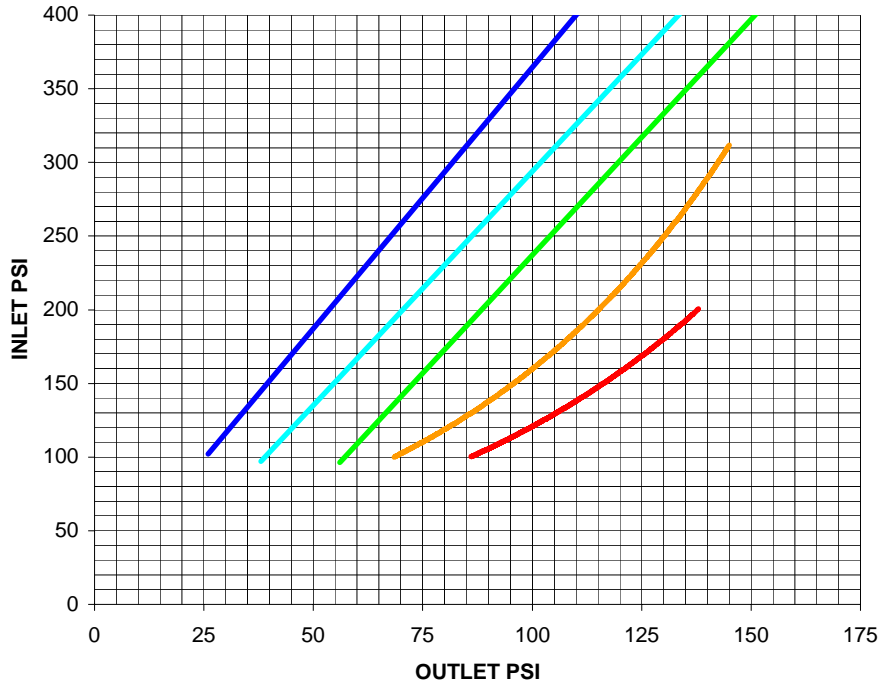

- SETTING A
- SETTING B
- SETTING C
- SETTING D
- SETTING E

URFA-20S-2.5
(200 GPM)

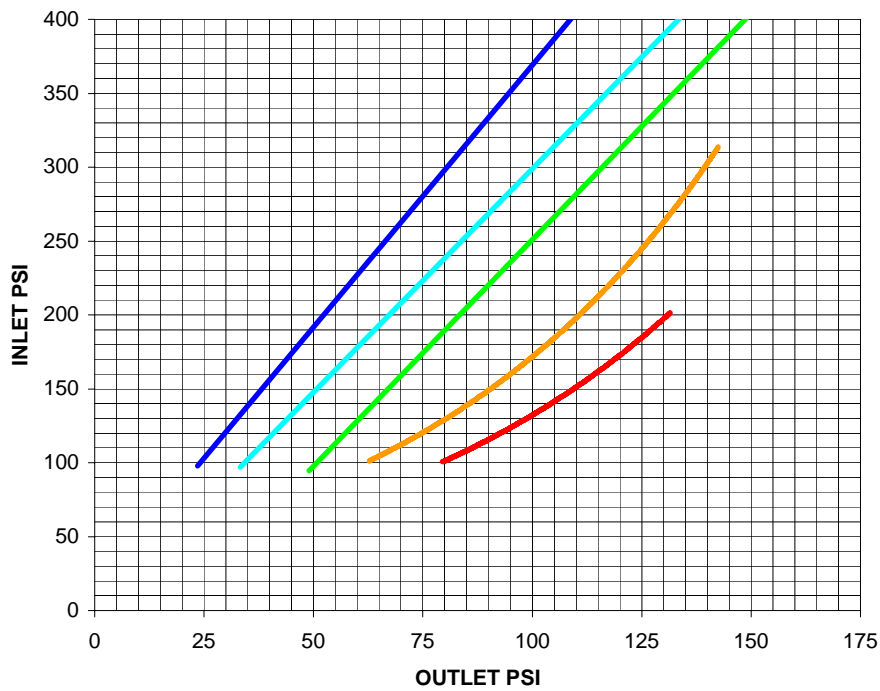

- SETTING A
- SETTING B
- SETTING C
- SETTING D
- SETTING E

URFA-20S-2.5
(250 GPM)

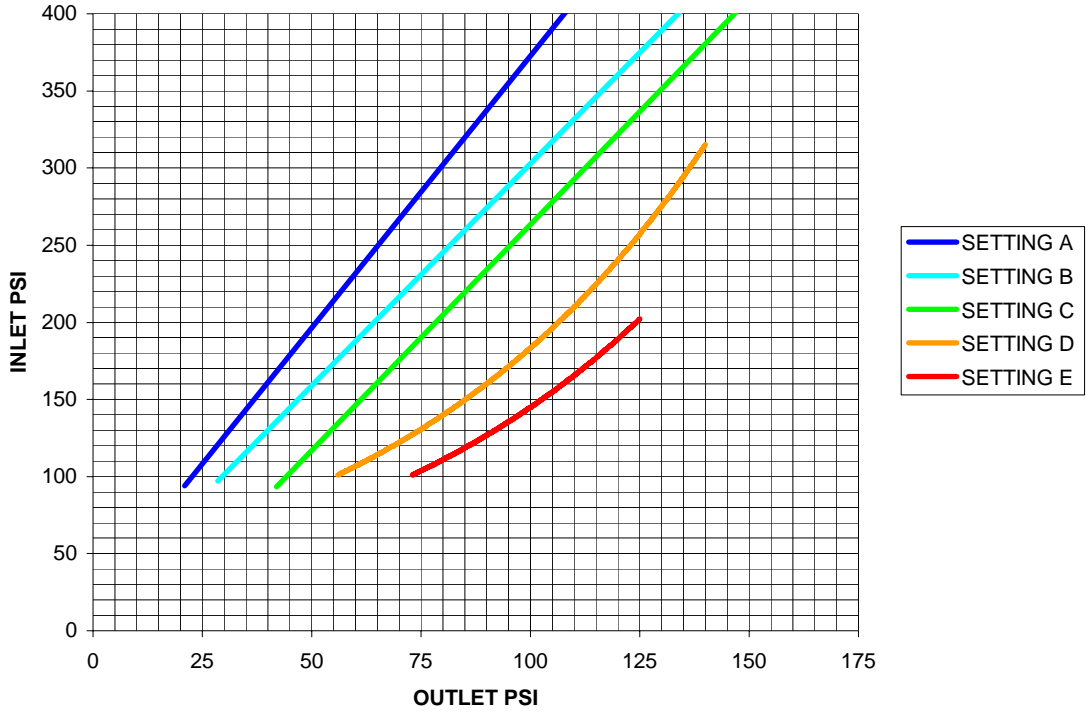

URFA-20S-2.5
(300 GPM)

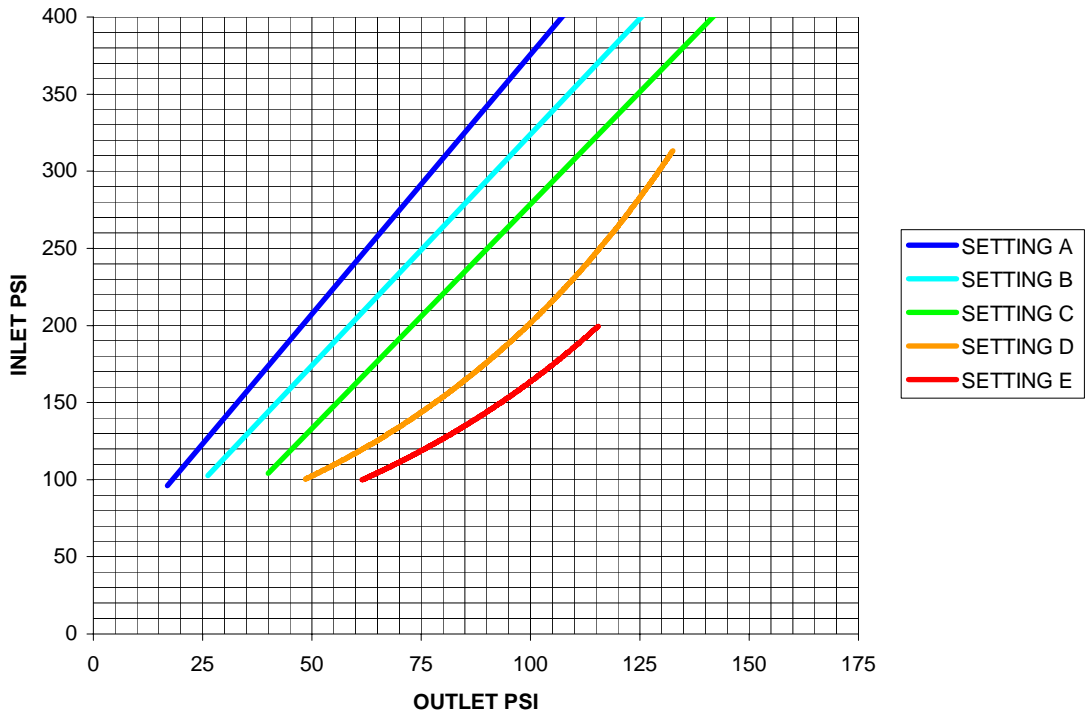

URFA-20S-2.5
(350 GPM)

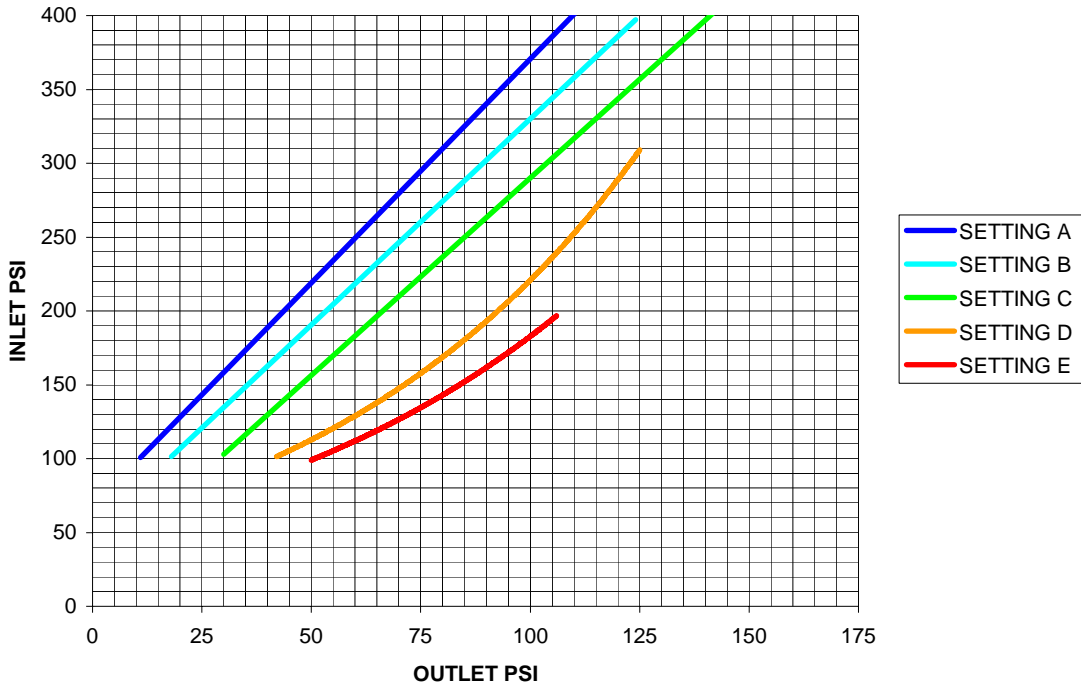

URFA-20S-2.5
(400 GPM)

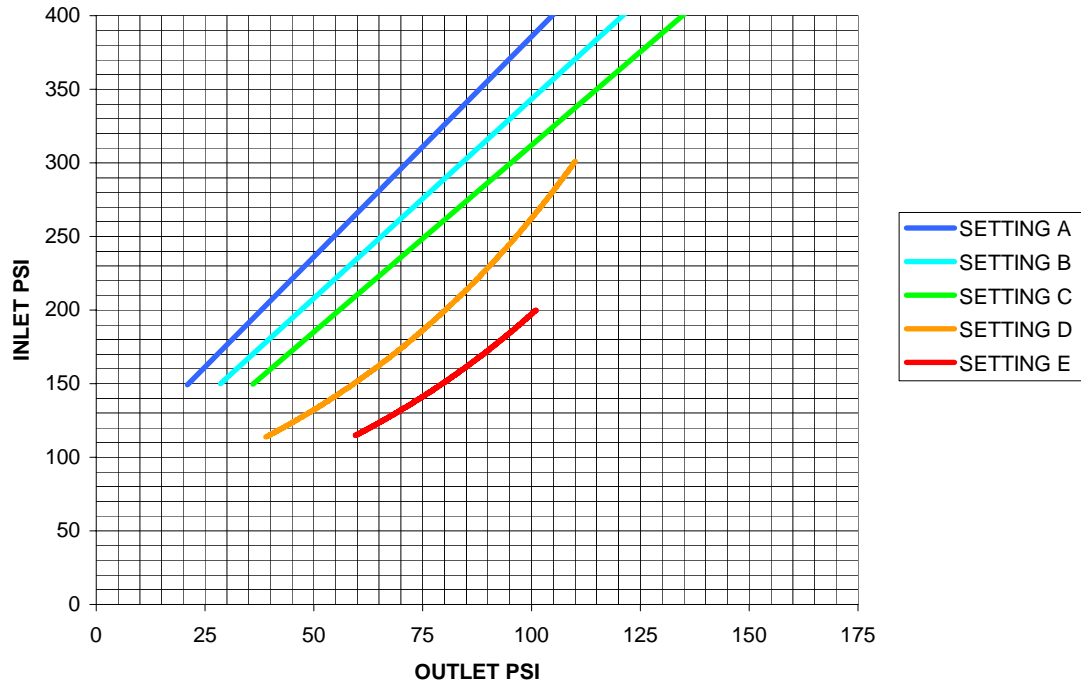

URFA-20S-2.5
(450 GPM)

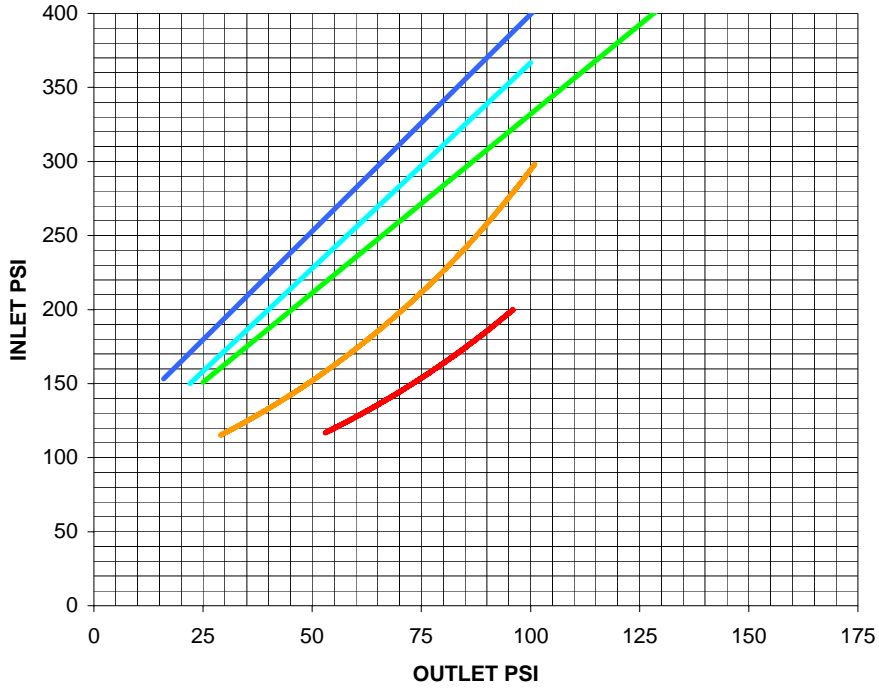

- SETTING A
- SETTING B
- SETTING C
- SETTING D
- SETTING E

URFA-20S-2.5
(500 GPM)

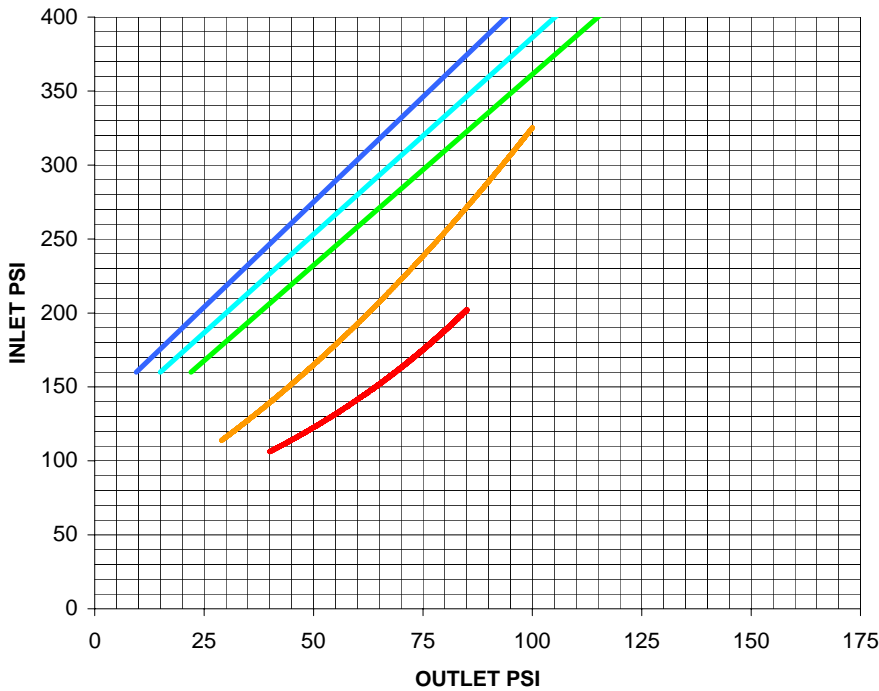

- SETTING A
- SETTING B
- SETTING C
- SETTING D
- SETTING E

STATIC PRESSURE REDUCTION

